

ADDENDUM #1
February 22, 2019

Request for Proposals – Landscape Maintenance
Stamford Downtown Special Services District (Stamford Downtown)
Stamford, CT

Landscape Maintenance

In 2019, the Streetscape Program will include:

- a) Six (6) gardens in three (3) Downtown parks
- b) Two (2) sidewalk gardens
- c) Forty (40) street planters
- d) One-hundred, eighty-five (185) hanging flower baskets

The contractor's scope of work will encompass the following activities:

- a) Spring preparation
- b) A minimum of three (3) seasonal plantings
- c) Fertilization
- d) Pruning
- e) Weeding
- f) Fall clean-up.

The selected contractor will follow the planting and maintenance guidelines created by Stamford Downtown's Landscape Design Vendor. Stamford Downtown estimates the purchase of approximately 800 annual plants for use in 2019.

The selected contractor will report directly to Stamford Downtown's VP of Operations and Landscape Design Vendor.

Watering

In 2019, the Streetscape Watering Program will encompass:

- a) Installation, removal, watering, fertilization and pruning of one-hundred, eighty-five (185) hanging baskets
- b) Watering and fertilization of forty (40) street planters and
- c) Watering and fertilization of nine (9) gardens at multiple locations including three (3) public parks.

The contractor's scope of work will encompass the following activities:

- a) Watering plantings in forty (40) ground planters from April through mid-May
- b) Installation, watering and fertilization of one-hundred, eighty-five (185) hanging baskets as needed from approximately Memorial Day to Columbus Day (Installation will begin at 4:30am and continue until all baskets are in place).
- c) Watering as needed through the end of June and daily from July 1st through Labor Day then again as needed until the end of October. Watering is to take place in the early morning while traffic volumes are lower.
- d) Fertilization of planters and hanging baskets as prescribed by Stamford Downtown's Landscape Designer

- e) Pruning of hanging baskets and planters as needed with watering
- f) Removal of trash from planters while watering and
- g) Removal of hanging baskets, and preparation for delivery for winter preparation, as determined by the Stamford Downtown Landscape Designer.

The term of the contract is April 1, 2019 – March 31, 2020. Stamford Downtown will make compensation on an hourly billing-basis.

Format of Response

Please submit the following:

- 1. Written background of your firm including a description of the firm’s related project experience
- 2. Photos samples of related experience
- 3. Description of, and resume’s for, the project management team assigned to this project
- 4. Fee proposal segregated according to the activities cited above:

Landscape Maintenance

- a) Spring preparation
- b) Implementation of a minimum of three (3) seasonal plantings
- c) Fertilizing
- d) Pruning
- e) Weeding
- f) Fall clean-up.

Watering

- a) Installation, removal, watering, fertilization and pruning of one-hundred, eighty-five (185) hanging baskets
 - b) Watering and fertilization of forty (40) street planters and
 - c) Watering and fertilization of nine (9) gardens at multiple locations including three (3) public parks.
5. Contract information for three (3) references

Stamford Downtown reserves the right to conduct interviews of prospective bidders.

Submittals are due by 12:00PM on March 1, 2019. Address submittals to the following:

Michael Moore
VP, Operations
Stamford Downtown
5 Landmark Square, Suite 110
Stamford, CT 06901

Direct any questions to Michael Moore at moore@stamford-downtown.com or (203) 348-5285.

Planters

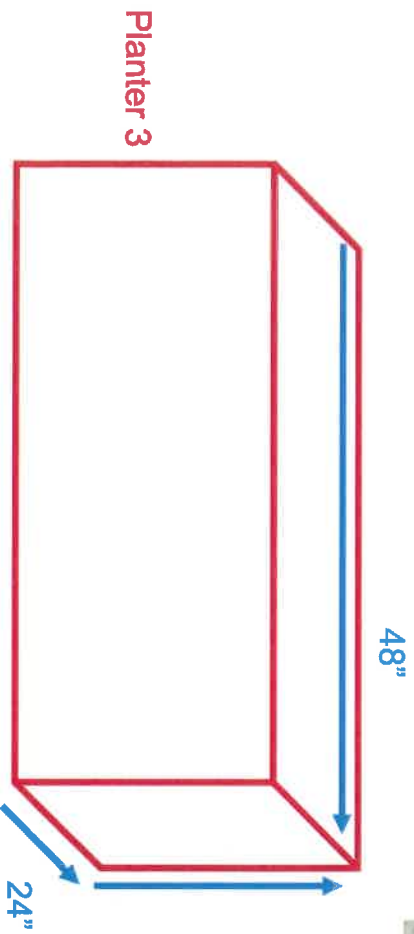
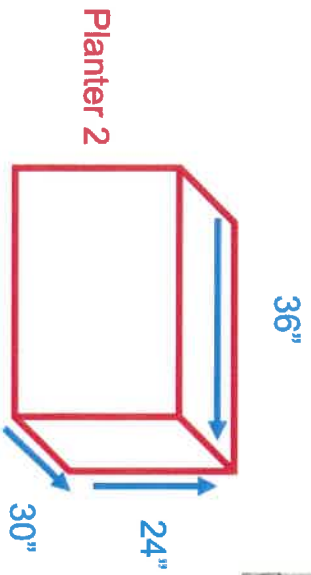
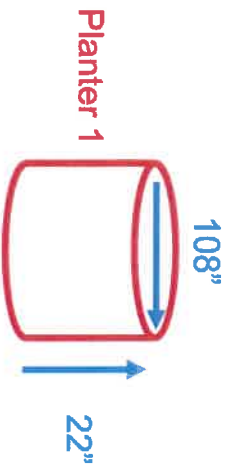

Sample Planter 3

Planter 4

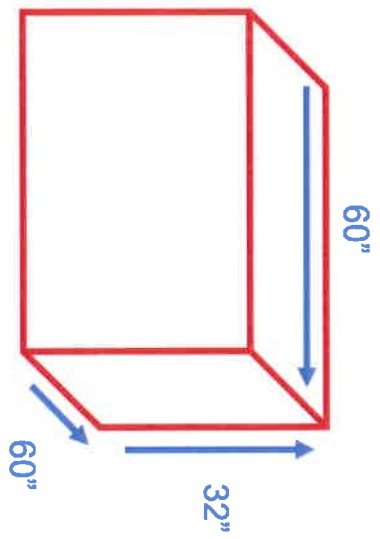

Sample Planter 4

Planter 5

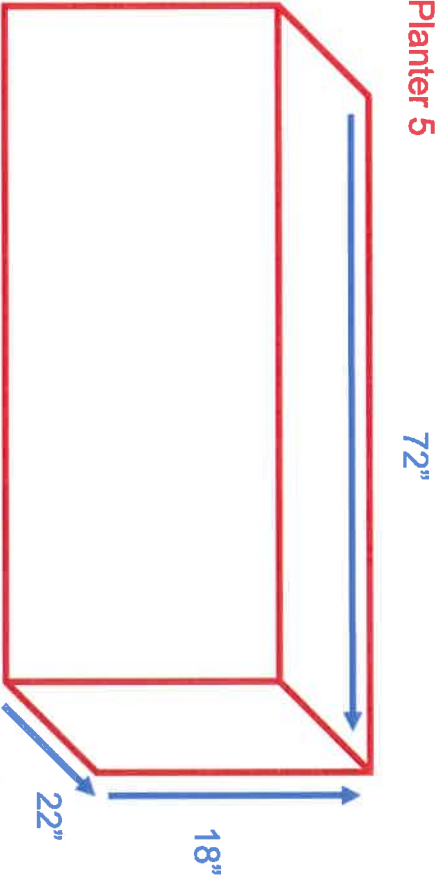

Sample Planter 5



Planter 6

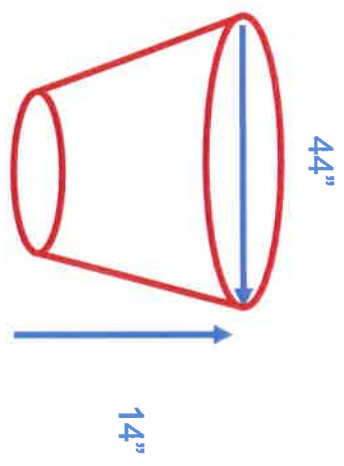

Map of Planter Locations

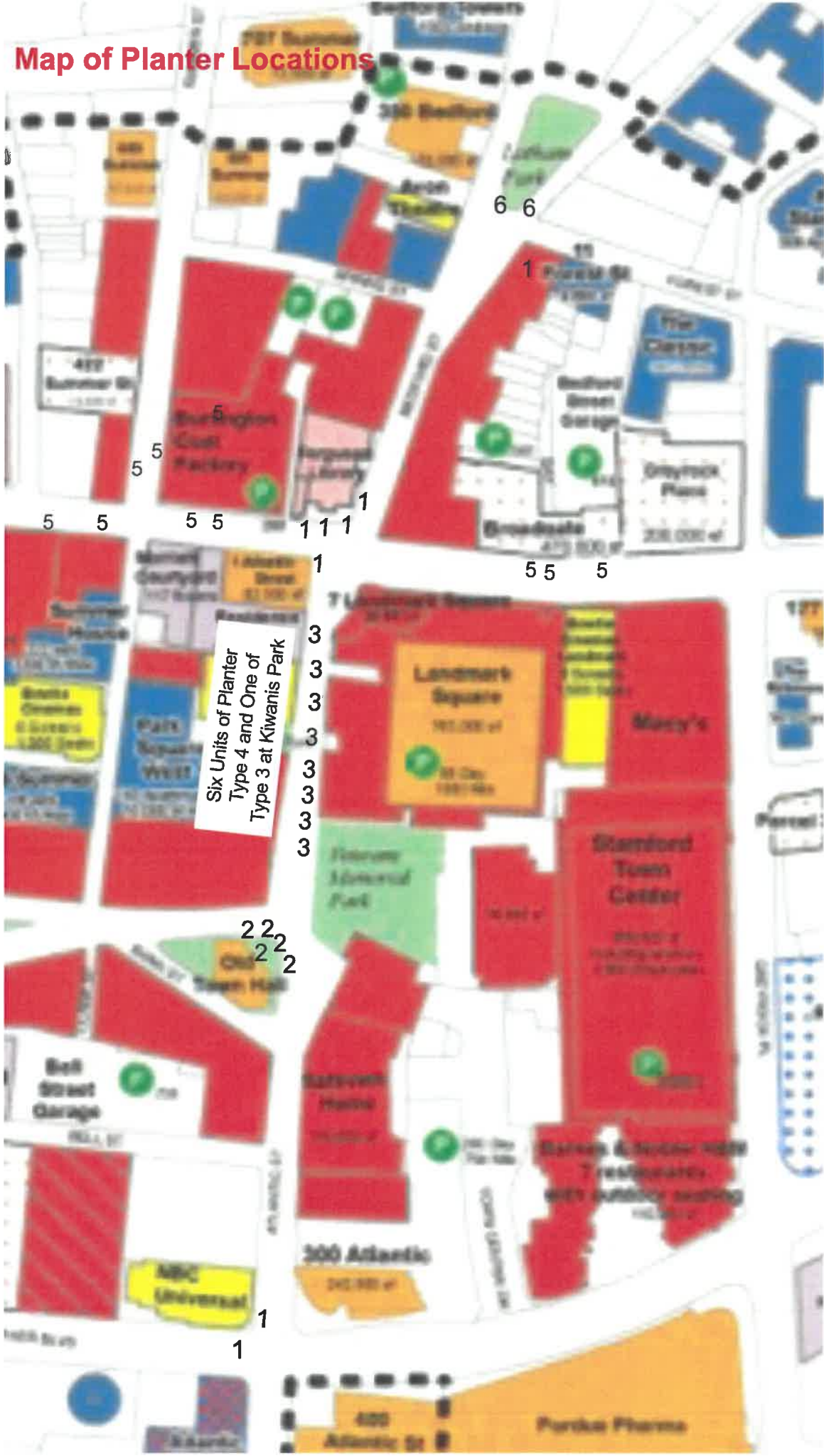

Six Units of Planter Type 4 and One of Type 3 at Kiwanis Park

